

NO.	NAME	MATERIAL	FINISH
1	Housing	Thermoplastic	
2	Terminal	Copper Alloy	Gold-Tin Plated
3	Shell	Alloy	Ni Plated

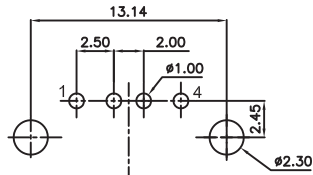

RECOMMENDED PCB LAYOUT  
TOP VIEW  
TOLERANCE: ±0.05mm  
PCB THICKNESS: 1.60±0.05mm

## TUA - S10 P2 B - B \* S

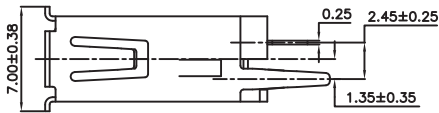
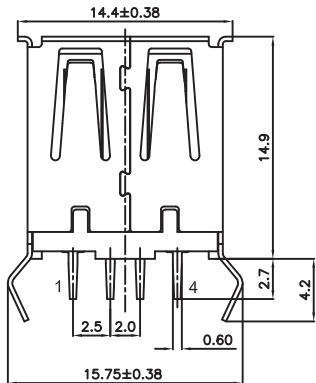
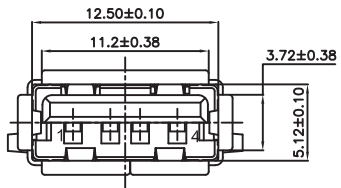
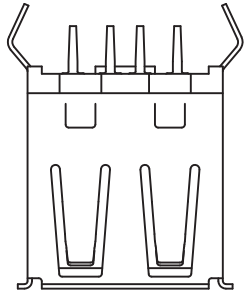
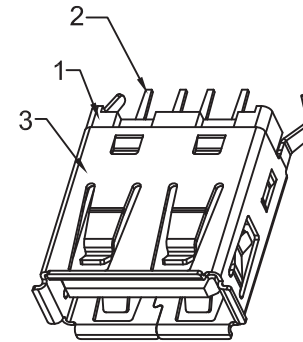
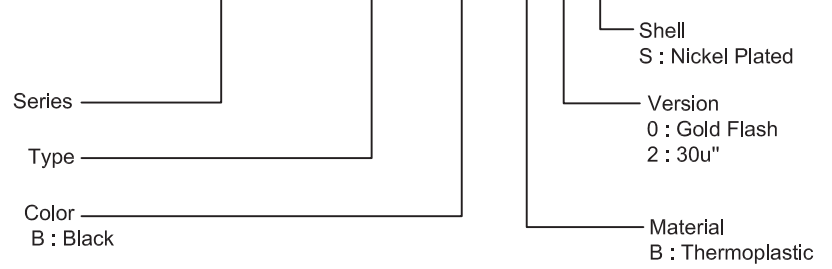

△			
△			
△			
△			
△			
SYM	DISCIPTION	DATE	APPROVED



**TACLEX**

TACLEX ELECTRONICS CO., LTD.

TOLERANCES UNLESS OTHERWISE SPECIFIED  
LINEAR: ±0.30 ANGULAR: ±3°

SIGNATURES

DATE

TITLE

DRAWN

Eric

2014/08/26

USB TYPE-A

CHK'D

Aaron

2014/08/26

NO.

TUA-S10P2-B0S

REVISIONS

A



SCALE

1:1

APPV'D

Rex

2014/08/26